



BB1 & BB2 INSTALLATION & MAINTENANCE INSTRUCTIONS

DESCRIPTION / IDENTIFICATION

The BB series valve uses Proportion- Air closed loop technology for pressure control. It gives an output pressure proportional to an electrical command signal input.

The BB1 is a complete closed loop servo system consisting of valves, manifold, housing and electronic controls. Pressure is controlled by the use of two solenoid valves. One valve functions as inlet control, the other as exhaust. The pressure output is measured by a pressure transducer internal to the BB1 and provides a feedback signal to the electronic controls. This feedback signal is compared with the command signal input. A difference between the two signals causes one of the solenoid valves to open, allowing flow in or out of the system. Accurate pressure is maintained by controlling these two valves.

The BB2 is similar to the BB1 but uses a double loop control scheme. In addition to the internal pressure transducer, the BB2 receives an electrical signal from an external sensing device that is provided with the valve. This primary feedback signal is compared against the command signal input. This comparison is then summed with the internal pressure transducer signal. The gain of the circuit is such that priority is given to the external feedback signal. A difference between the command signal and the feedback signal causes one of the solenoid valves to be activated.

A monitor output is available as an option to monitor system pressure. The BB1 monitor output is an amplified signal from the internal pressure transducer. The BB2 monitor output is a buffered signal from the external transducer connected to the BB2.

For BB valves with model number FEE or FIE the monitor output is voltage. For valves with model number FEC or FIC, the monitor output is current. See ordering information for further details.

SPECIFICATIONS

ELECTRICAL

SUPPLY VOLTAGE.....	15-24 VDC
SUPPLY CURRENT.....	.250mA req'd.
COMMAND SIGNAL	
VOLTAGE.....	0-10 VDC
CURRENT.....	4-20mA Sinking
CURRENT (S191/S143).....	4-20mA Differential
COMMAND SIGNAL IMPEDANCE	
VOLTAGE.....	4230 to 5170 Ω
CURRENT.....	420 to 520 Ω
CURRENT (S191).....	100 Ω
CURRENT (S143).....	25.5 Ω
ANALOG MONITOR SIGNAL	
VOLTAGE.....	0-10 VDC @ 10mA max
CURRENT.....	4-20mA sinking
CURRENT (S216).....	4-20mA sourcing
TTL MONITOR OUTPUT.....	0-5Vdc @20mA
DIGITAL INPUT SIGNAL.....	2.5-24Vdc @1mA
DIGITAL LATCH TIME.....	200 μ s
DIGITAL LATCH LOGIC.....	Latched-High

MECHANICAL

PRESSURE RANGES†.....	29.9 in. Hg (vac) - 500 psig (760 mmHg (vac) - 34.47 BAR)
FLOW RATE.....	1.2 SCFM max @ 100 psig inlet (34L/min @ 6.89 BAR)
FLOW RATE (S81).....	3.5 SCFM max @ 100 psig inlet (99L/min @ 6.89 BAR)
Cv CAPACITY.....	0.04
Cv CAPACITY (81).....	0.13
MIN. CLOSED END VOLUME.....	1 in ³
FILTRATION RECOMMENDED.....	40 micron nominal
LINEARITY/HYSTERESIS.....	< \pm 0.15% F.S. BFSL
REPEATABILITY.....	\pm 0.02% F.S.
ACCURACY.....	\pm 0.2% F.S.
WETTED PARTS‡.....	Elastomers - Fluorocarbon Manifold - Brass Valves - Nickel plate brass P. Transducer - Silicon, Aluminum

PHYSICAL

OPERATING TEMPERATURE.....	32-158°F [0-70°C]
WEIGHT.....	1.02 lb [0.50 Kg]
PROTECTION RATING.....	NEMA 1 (IP50)
HOUSING.....	Anodized Aluminum
FINISH.....	Black Anodized

† Pressure ranges are customer specified.

‡ Others available

INSTALLATION

See **FIGURE 1** for ports location

CAUTION: USE ONLY THE THREAD SEALANT PROVIDED. OTHER SEALANTS SUCH AS PTFE TAPE AND PIPE DOPE CAN MIGRATE INTO THE FLUID SYSTEM CAUSING FAILURES.

WORK PORT:

1. Remove the cap from the work port located at the bottom of the BB valve.
2. Connect device being controlled to work port of the BB valve.
3. The bottom fitting has an o-ring seal between itself and the BB valve. If you remove the bottom fitting, DO NOT damage the o-ring that seals the bottom fitting to the BB control valve.
4. The valve can be mounted in any position without affecting performance. Mounting bracket BKT-01 (ordered separately) can be used to attach valve to a panel or wall surface.
5. Proceed with electrical connections.

INLET PORT:

1. The pressure inlet port is located on the side of the BB valve.
2. A white warning sticker is placed over the inlet port of the BB valve to keep contamination out during shipping. Remove this sticker to expose the inlet port.
3. Apply a small amount of anaerobic sealant (provided) to the male threads of the in-line filter supplied with valve.
4. Install the in-line filter into the inlet port on BB valve.
5. Connect supply line to the in-line filter port not to exceed rated supply pressure. (TABLE 1)

LED LIGHTS:

The RED LED on top of the unit illuminates showing that power is supplied to the unit. Models with monitor optional or TTL signal have a GREEN LED in addition to the RED LED. The GREEN LED illuminates when the device is satisfied, output is within 1% of the set point. The unit may pulsate while “settling in” due to the compressibility of the media and the pneumatic circuit. This is normal under static conditions.

TABLE 1

RATED INLET PRESSURE FOR STANDARD BB VALVES

For valves ordered with MAX. calibrated pressure of:	Max. inlet pressure is:
Vacuum up to 10 psig (0.69 bar)	Consult factory
10.1 up to 30 psig (0.70 up to 2 bar)	35 psig (2.4 bar)
31 up to 100 psig (2.1 up to 7 bar)	110 psig (7.6 bar)
101 up to 175 psig (7 up to 12 bar)	190 psig (13 bar)
176 up to 300 psig (12.1 up to 20.7 bar)	330 psig (22.8 bar)
301 up to 500 psig (20.8 to 34.5 bar)	550 psig (37.9 bar)

NOTE: Valves with options S67, S91, or S106 can handle higher inlet pressures. Inlet pressures are not the same for valves mounted to volume boosters. Consult factory for further information.

FIGURE 1

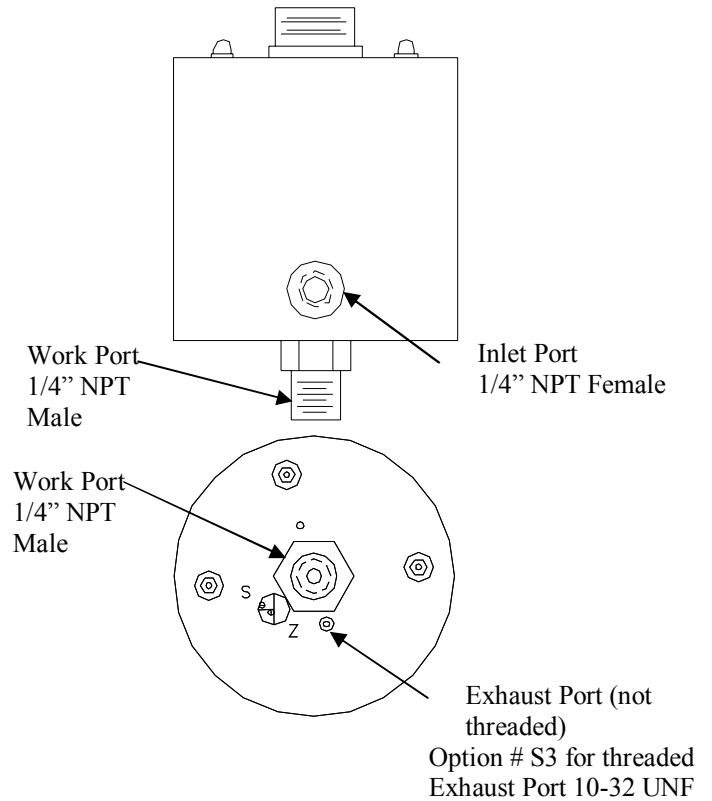

ELECTRICAL CONNECTIONS

1. Turn off all power to valve.
2. Identify the valve's command input and analog output using the calibration card included in the package and the ordering information section on the last page of this sheet.
3. Proceed to the appropriate section corresponding to the type of valve being installed.

NOTE: ALL COLOR CODES RELATE TO BB'S POWER CORDS (see ordering information for a complete list of available cords).

3 PIN BB VALVES

Voltage command valves, 3 PIN

All voltage command BB's use common mode voltage, meaning the DC Common pin (Pin 1) is the common reference for both power and command. Pin 1 is used as both the command signal common and power supply common. The following diagram shows the proper connections.

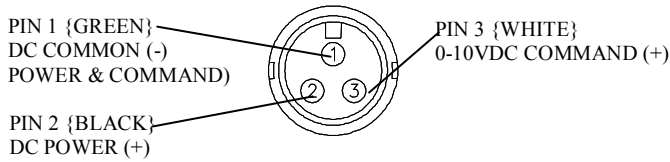

Current command valves, 3 PIN (standard Sinking input)

Use the following wiring diagram for BB valves with a sinking command input

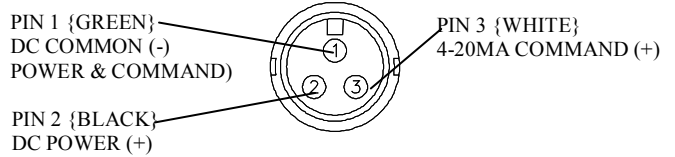

5 PIN BB VALVES

Voltage command valves, 5 PIN

All voltage command BB's use common mode voltage, meaning the DC Common pin (Pin 3) is the common reference for both power and command. Pin 3 is used as both the command signal common and power supply common. The following diagram shows the proper connections.

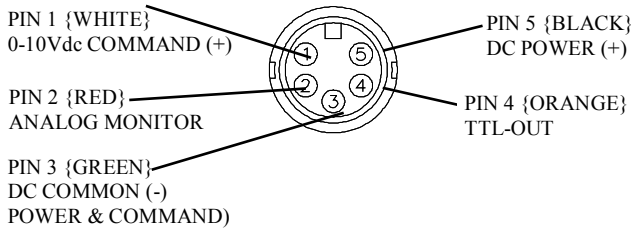

Current command valves (S143, S191 differential input option)

BB's with S191 use a differential current loop scheme (not isolated), meaning current flow is from Pin 1 to Pin 2 on the BB valve. Some applications may require the common of the power supply that provides loop power for the 4-20mA command to be tied to power supply common. The following diagram shows the correct connection for conventional current flow.

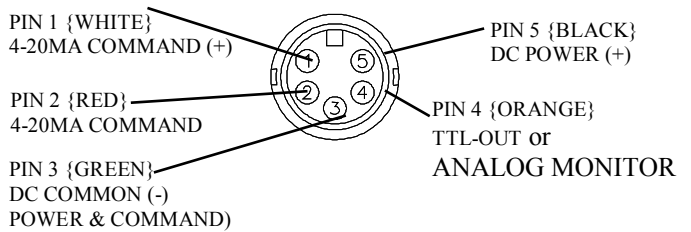

Digital command valves, 13 PIN

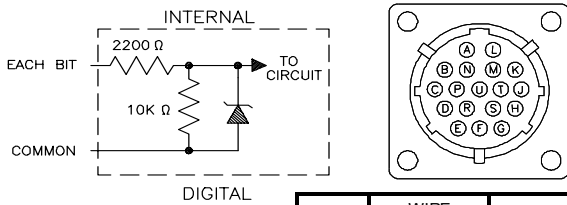

PIN #	WIRE COLOR	FUNCTION
A	PINK	BIT 1 (MSB)
B	GRAY	BIT 2
C	VIOLET	BIT 3
D	BROWN	BIT 4
R	BLUE	BIT 5
P	YELLOW	BIT 6
N	WHITE	BIT 7
L	TAN	BIT 8 (LSB)
M	ORANGE	TTL-OUT
U	RED	ANALOG OUT
K	GREEN	(-) DC COMMON
G	BLACK	(+) POWER
J	RED/YELLOW	LATCH

Current command valves, 5 PIN (standard Sinking input)

Use the following wiring diagram for BB valves with a sinking command input

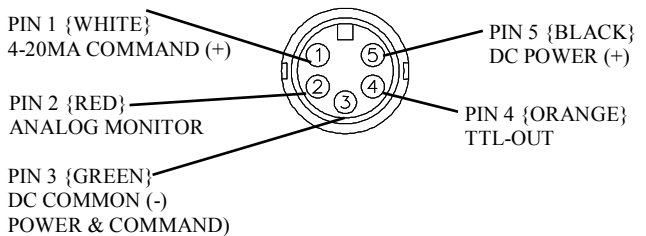

ANALGO MONITOR OPTION

Voltage monitor (FEE or FIE)

Use the following wiring diagram for BB valves with a voltage monitor output.

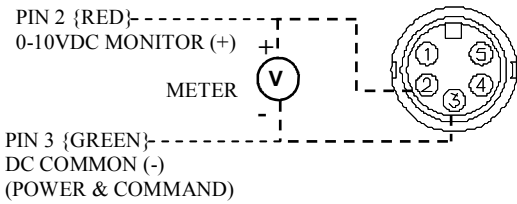

TTL-output

BB valves with analog monitor option have an additional output line. The TTL signal is a conditional ON/OFF signal to use for diagnostic purposes. The signal is LOW when the pressure is within 1% of final setting.

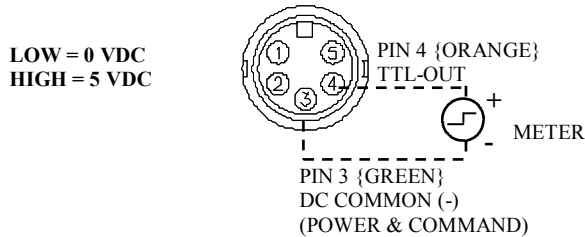

Current monitor (FEC or FIC)

Use the following wiring diagram for BB valves with a current sinking monitor output.

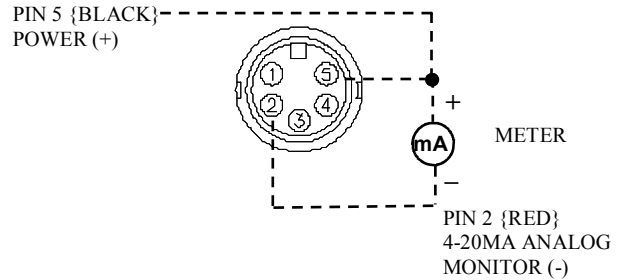

Current monitor (S143 or S191 option)

Use the following wiring diagram for BB valves with a current sinking monitor output.

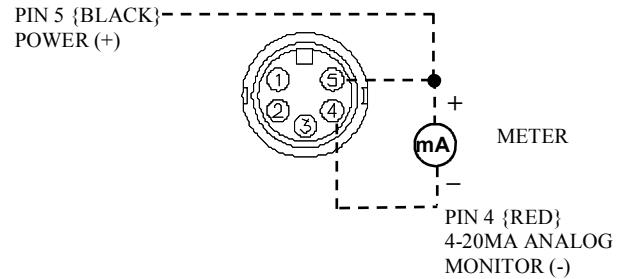

BB2 SECOND LOOP CONNECTIONS

Each BB2 valve comes with a matched pressure transducer for second loop feedback input unless an S59 option (no external pressure transducer) is ordered with the valve. 0-10Vdc BB2 valves are designed to accept a 0-10 volt second loop input signal, 4-20mA command units accept a 2 to 9 Vdc second loop signal (DSZ Series), unless ordered with special option code S143 or S191 differential command input. Valves with S230 option accept a 4-20mA second loop input. See wiring below.

BB2-Standard valves

Second loop input is 0-10Vdc.

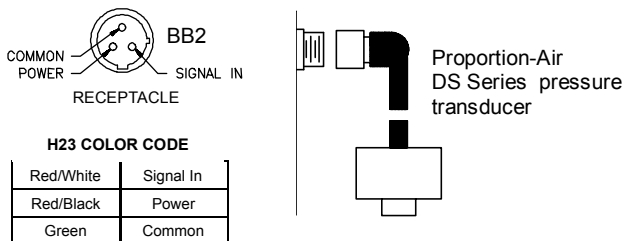

BB2-S230 option valves

Second loop input is 4-20mA. To facilitate wiring between the BB2 and the 4-20mA external pressure transducer, an auxiliary adaptor cord, H23, should be ordered.

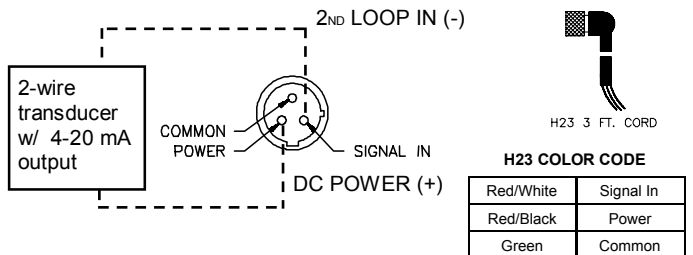

RE-CALIBRATION PROCEDURE

Each control valve or transducer is hand built to your requirements and custom calibrated by trained personnel using precision calibration equipment. Each product contains a precision electronic pressure sensor has a typical drift less than 1% over the life of the product. If your product appears to be out of calibration by more than 1%, it is not likely that the product is faulty. Check the system for adequate supply pressure, wiring and electronic signal levels. Verify the accuracy of your measuring equipment before re-calibrating. Consult factory if you have any questions or require assistance.

BB1 VALVES

1. Identify the inputs and outputs of the valve using the model number of the valve, calibration card included with the valve, and the information provided in this sheet.
2. Connect a precision measuring gage or pressure transducer to the OUT port of the BB.
NOTE: THERE MUST BE A CLOSED VOLUME OF AT LEAST 1 CU. IN. (17 CC) BETWEEN THE VALVE OUTLET AND THE MEASURING DEVICE FOR THE VALVE TO BE STABLE.
3. Connect the correct supply source to the IN port of the BB, making sure the pressure does not exceed the rating for the valve (See Table 1).
4. Locate the calibration access hole at the bottom of the BB valve. There are two adjustment trimpots, Zero "Z" and Span "S". See figure 1 for pot locations.
5. NOTE: Only use this step if your device is totally out of calibration. If it is slightly out of calibration, omit this step and move on to paragraph 6. Using a small screwdriver, turn both trimpots 15 turns clockwise. Then turn both trimpots 7 turns counterclockwise. This will put the BB roughly at mid-scale.
6. Make correct electrical connections per "ELECTRICAL CONNECCTIONS". Make sure there is a proper meter in place to measure the command input to the BB.
7. Set the electrical command input to MAXIMUM value.
8. Adjust the SPAN pot until MAXIMUM desired pressure is reached.
9. Set the electrical command input to 10 percent of full valve (1Vdc for 0-10Vdc valves or 5.6mA for 4-20mA valves).
10. Adjust the ZERO pot until 10 percent of maximum desired pressure is reached.
11. Repeat ZERO and SPAN adjustments, which interact slightly, until BB1 valve is calibrated back to proper range. Step 7-10.
12. Verify calibration at several setpoints across the operating range (25%, 50%, 75%, 100% and 0%) to ensure that the unit's output is linear. It is important to verify that the unit goes to 0 command. Adjust zero potentiometer slightly counterclockwise until there is no pressure output. Verify calibration across the full range once again and make adjustments as necessary.

BB2 VALVES

All BB2 valves come with a matched DS Series pressure transducer for second loop feedback input. This section assumes that the transducer is a properly scaled and calibrated. For information on re-calibrating Proportion-Air DS series pressure transducers see sheet BRDS-WT.

1. Follow, in order, steps 1-5 as noted in the section titled BB1 VALVES .
2. Make correct electrical connections as noted. Make sure there is a proper meter in place to measure the command input to the BB2. Make sure the 2nd loop signal is connected.
3. Set the electrical command input to MAXIMUM value.
4. Adjust the SPAN pot until MAXIMUM desired pressure is reached.
5. Set the electrical command input to 10 percent of full valve (1Vdc for 0-10Vdc valves or 5.6mA for 4-20mA valves).
6. Repeat ZERO and SPAN adjustments, which interact slightly, until BB2 valve is calibrated back to proper range. Steps 3 - 5.
7. Verify calibration at several setpoints across the operating range (25%, 50%, 75%, 100% and 0%) to ensure that the unit's output is linear. It is important to verify that the unit goes to 0 command, adjust zero potentiometer slightly counterclockwise until there is no pressure output. Verify calibration across the full range once again and make adjustments as necessary.

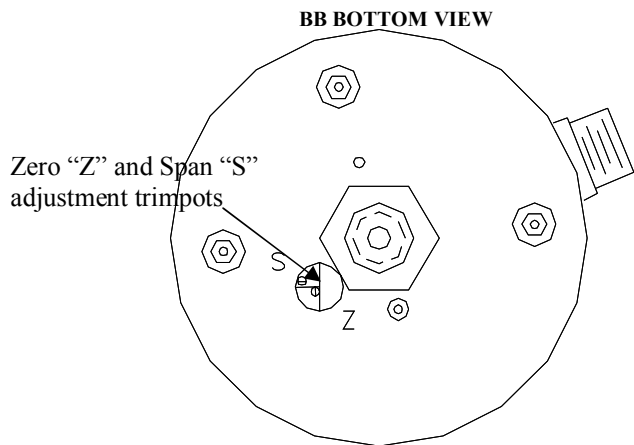

DIMENSION inches (mm)

BB

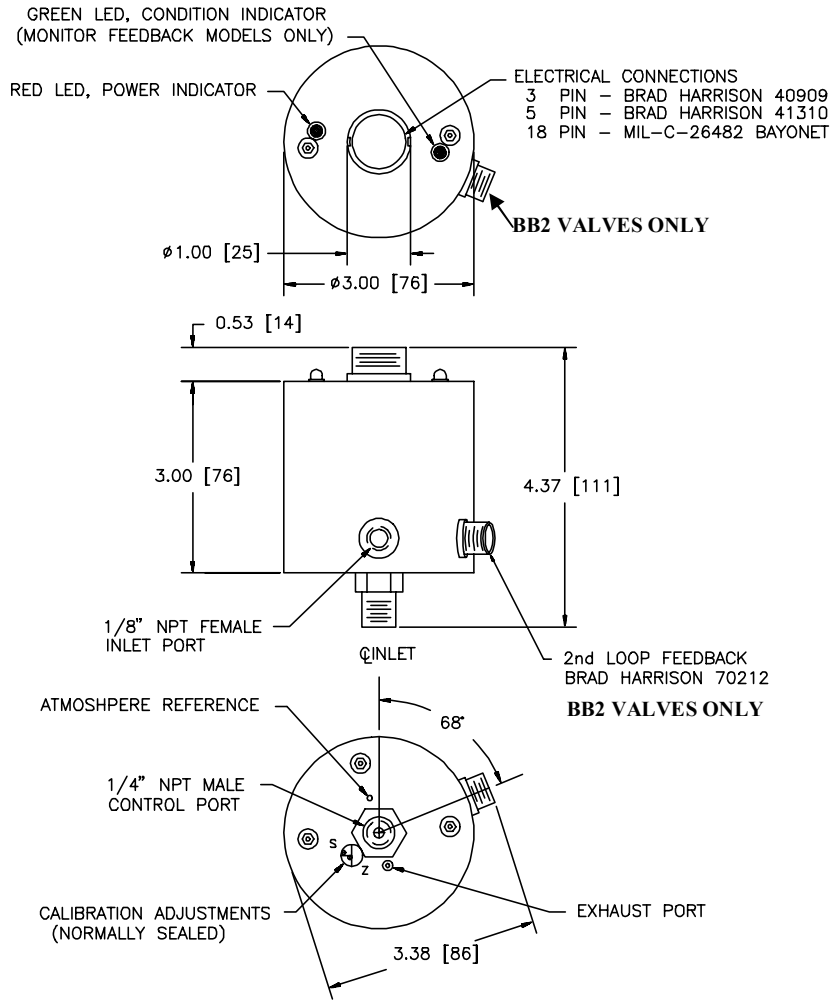

BKT-01 BRACKET

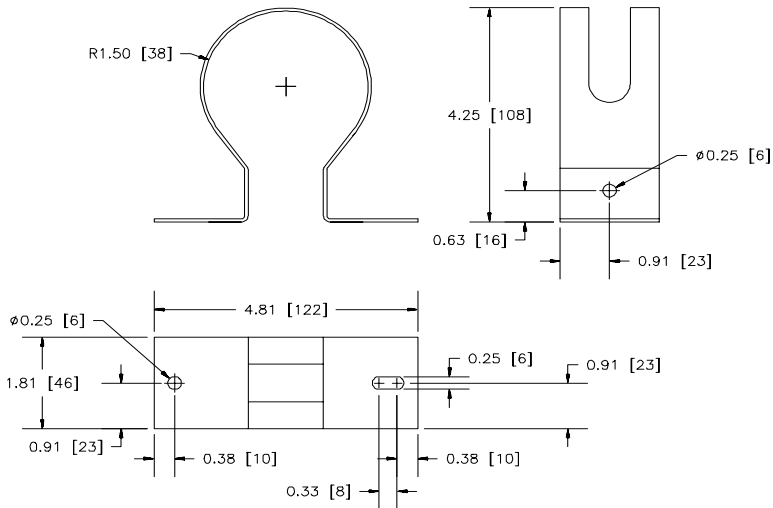

DS SERIES PRESSURE TRANSDUCER

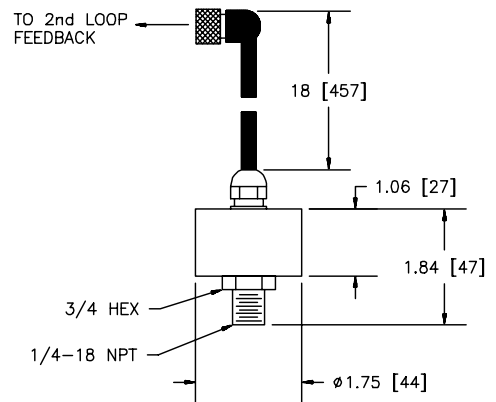

BB ORDERING INFORMATION

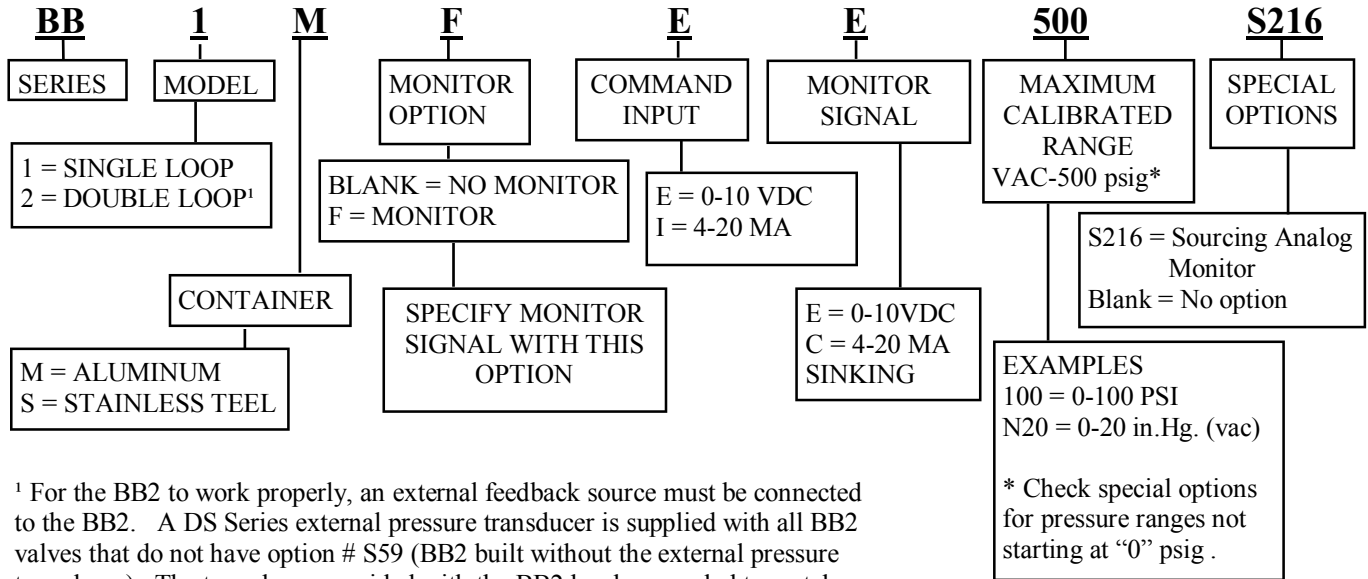

¹ For the BB2 to work properly, an external feedback source must be connected to the BB2. A DS Series external pressure transducer is supplied with all BB2 valves that do not have option # S59 (BB2 built without the external pressure transducer). The transducer provided with the BB2 has been scaled to match the pressure range specified when the BB2 was ordered. For complete information on the DS Series, please refer to brochure # BRDS-WT.

POWER CORD

3 PIN CORDS	
H6033	3' length
H6036	6' length
H6312	12' length
H6315	15' length
H6320	20' length
5 PIN CORDS	
H6053	3' length
H6056	6' length
H6512	12' length
H6515	15' length
H6520	20' length
DIGITAL CORDS	
13 PC-10	10' length (Additional lengths available)
H618P	Electrical Connector. No Cord.

MOUNTING BRACKET

BKT-01

Proportion-Air products are warranted to the original purchaser only against defects in material or workmanship for one (1) year from the date of manufacture. The extent of Proportion-Air's liability under this warranty is limited to repair or replacement of the defective unit at Proportion-Air's option. Proportion-Air shall have no liability under this warranty where improper installation or filtration occurred.

All specifications are subject to change without notice. **THIS WARRANTY IS GIVEN IN LIEU OF, AND BUYER HEREBY EXPRESSLY WAIVES, WARRANTIES OR LIABILITIES, EXPRESSED, IMPLIED OR STATUTORY, INCLUDING WITHOUT LIMITATION ANY OBLIGATION OF PROPORTION-AIR WITH REGARD TO CONSEQUENTIAL DAMAGES, WARRANTIES OF MERCHANTABILITY, DESCRIPTION, AND FITNESS FOR A PARTICULAR PURPOSE.**

WARNING: Installation and use of this product should be under the supervision and control of properly qualified personnel in order to avoid the risk of injury or death.

PROPORTION-AIR, INC. BOX 218 MCCORDSVILLE, IN USA 46055

PHONE: (317)335-2602 FAX: (317)335-3853

web site: www.proportionair.com

email address: info@proportionair.com